

22 GENERATOR

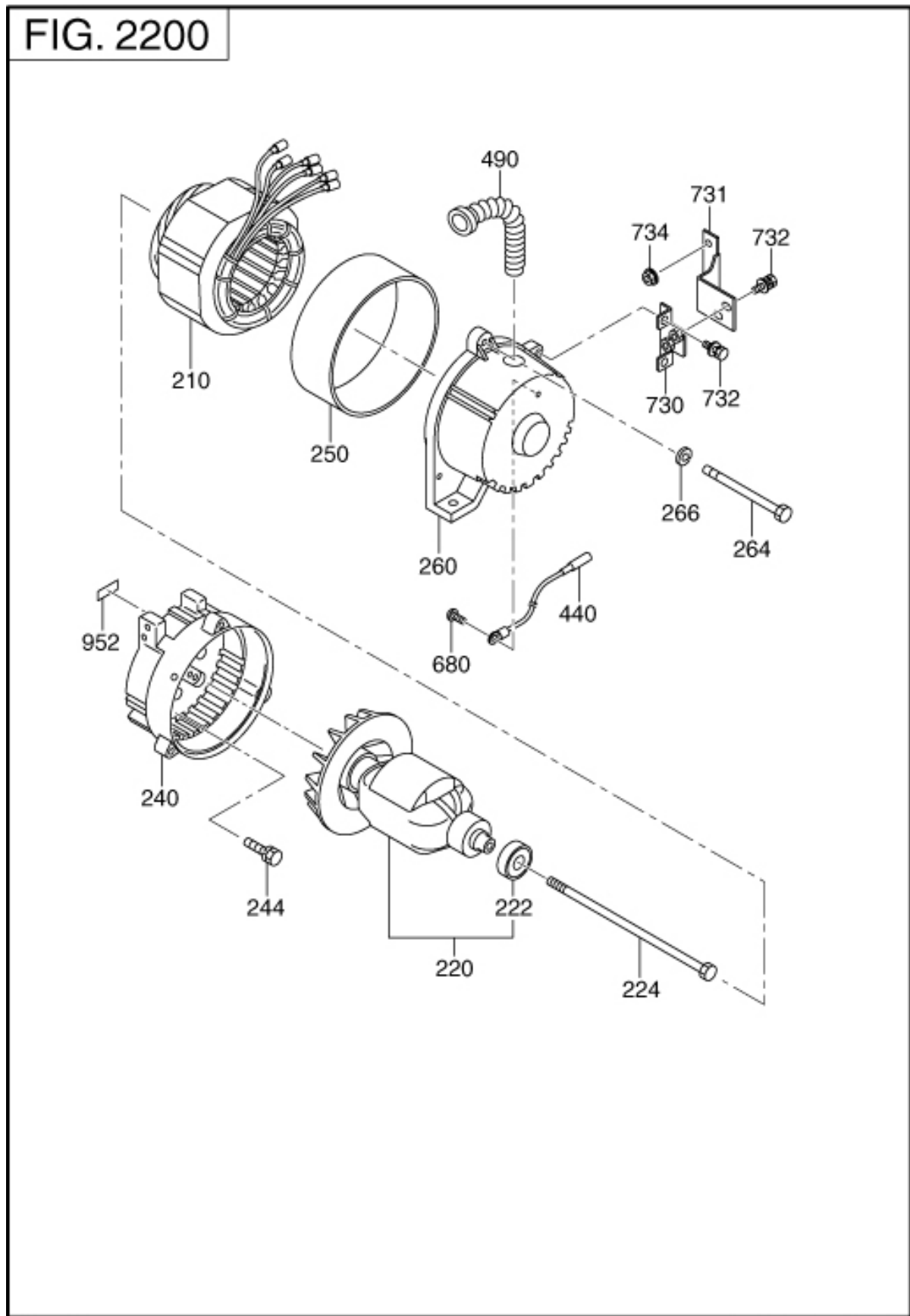

REF.	PART NUMBER	PART NAME	CODE NO.	QTY	REMARKS	INTERCHANGE
210	35B-51013-01	STATOR CP	-	1		
220	35B-51001-01	ROTOR CP	-	1		35B-51015-01
222	353-58208-08	BALL BEARING	-	1		
224	366-58016-08	THROUGH BOLT	-	1		
240	367-54113-08	FRONT COVER	-	1		388-55611-01
244	359-59935-08	BOLT & WASHER AY	-	4		
250	367-54508-08	STATOR COVER	-	1		
260	35A-52001-01	REAR COVER	-	1		
264	389-55802-03	COVER BOLT	-	3		
266	003-20060-00	SPRING WASHER	-	3	6. 1DX12. 2DX1. 5T	
440	35A-53001-01	WIRE CP	-	1		
490	353-57506-18	BUSHING	-	1		
680	004-31030-60	SCREW,PANHEAD	-	1		
730	35A-63001-01	MUFFLER BRACKET A	-	1		
731	35B-63001-01	MUFFLER BRACKET B	-	1		
732	359-59935-08	BOLT & WASHER AY	-	4		
734	002-38080-00	FLANGE NUT	-	2	M8X1. 25X17DX7. 5H	