

22 GENERATOR

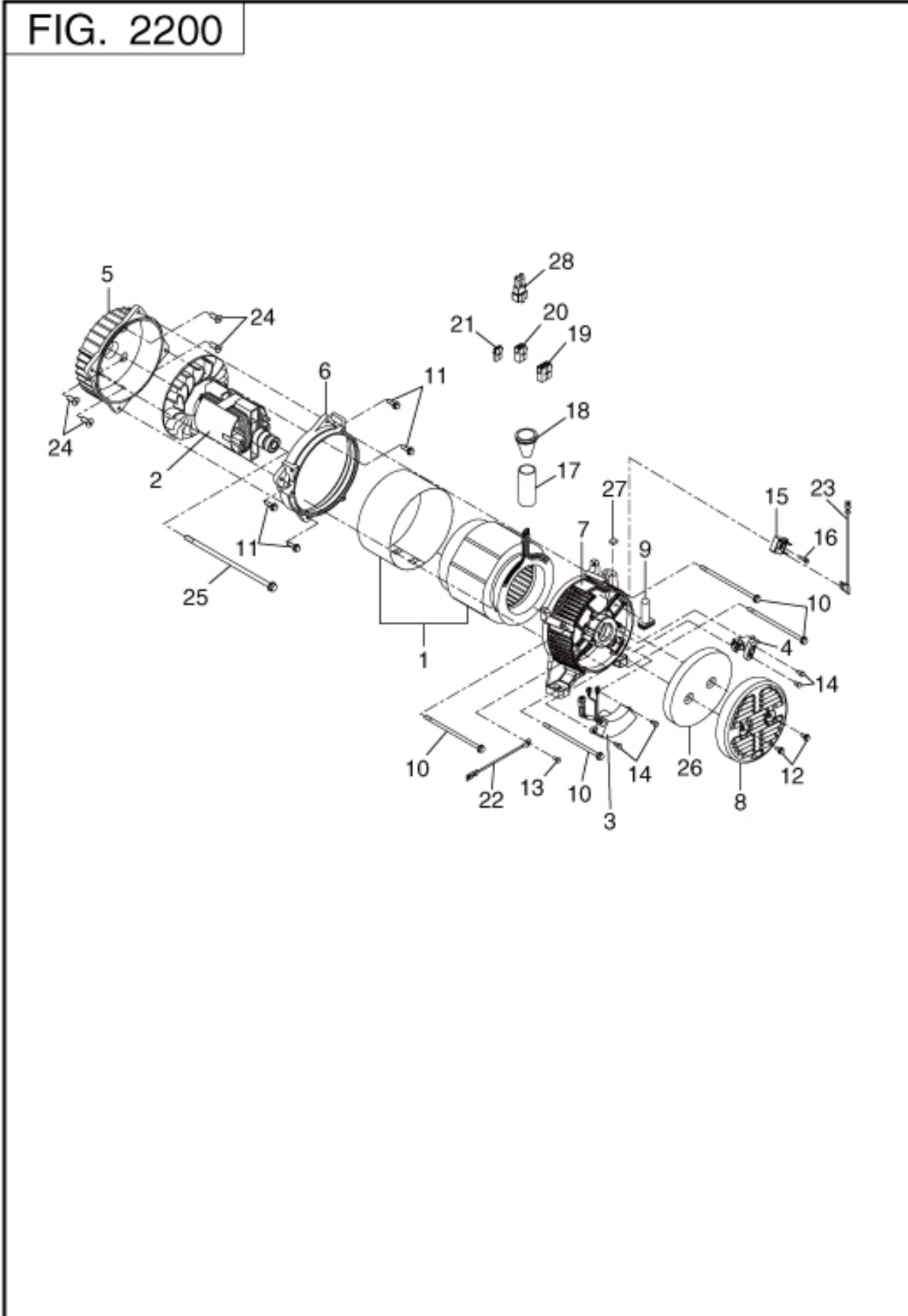

REF.	PART NUMBER	PART NAME	CODE NO.	QTY	REMARKS	INTERCHANGE
1	RGN15250450000	STATOR CP	-	1		RGN15250450002
2	36C-20101-08	ROTOR CP	-	1		RGN15200454002
3	RGN15400216000	AVR CP	-	1		
4	36A-20300-08	BRUSH CP	-	1		
5	36C-22000-08	GEN BRACKET 1	-	1		
6	36C-22100-08	GEN BRACKET N	-	1		
7	36C-22200-08	GEN BRACKET 2	-	1		
8	36C-23000-08	BRACKET COVER	-	1		
9	RGN15350583000	BUSHING	-	1		
10	RGN15550302000	STATOR BOLT M6-165	-	4		
11	RGN15550292000	FLANGE BOLT	-	4		
12	RGN15550306000	FLANGE BOLT M5-20	-	2		
13	RGN15550307000	SCREW & WASHER AY	-	1		
14	RGN15550308000	FLANGE BOLT M5-16	-	4		
15	RGN15400389000	DIODE CP	-	1		
16	RGN15550289000	FLANGE BOLT M4-18	-	1		
17	RGN15350586000	TUBE	-	1		
18	RGN15350584000	GROMMET	-	1		
19	RGN15400399000	CONNECTOR(6P)	-	1		
20	RGN15400398000	CONNECTOR(4P)	-	1		
21	RGN15400397000	CONNECTOR(2P)	-	1		
22	RGN15502009000	WIRE(GREEN)	-	1		
23	RGN15501988000	WIRE(WHITE)	-	1		
24	RGN15550309000	SCREW M8-20	-	4		
25	RGN15550296000	ROTOR BOLT	-	1		
26	RGN15350594000	SPONGE(FILTER)	-	1		
27	RGN15350592000	SPONGE	-	2		
28	RGN15502010000	CONNECTOR AY	-	1		